

AVK MAGNUS BALL VALVES



		<h1>EXPECT SUPREME PE BALL VALVES</h1>	<p>Expect... AVK</p>
			

AVK MAGNUS RANGE

The AVK MAGNUS Series 85/50 is an extensive range of PE ball valves up to OD180mm, which have been extensively and independently type tested against worldwide leading standards such as EN1555-4 and EN12201-4.

The AVK MAGNUS ball valves have undergone additional testing over and above that required in the specification. This ensures that the valve is suitable for distribution systems and environments anywhere in the world.

The extensive AVK MAGNUS ball valve range consists out of multiple sizes starting as of OD25 up to OD180mm. Depending on the requested pressure rating the valves are available with SDR11 or SDR17.6 spigot ends.

The valves are UNIVERSAL, meaning the same valve can be used for multiple application areas. The selected materials are tested and approved for both GAS and WATER applications. When used in GAS applications the valves are rated as MOP 10 and in case of WATER applications PN 16.



ACCESSORIES & OPTIONS

As with all valves, best practice techniques should be used during installation and operation. To aid this process a series of recommended accessories is available, this includes a reliable installation and access system, retro fit extension spindles and lever operation.

The valve access system consists of a support base, down pipe, surface box adaptor and surface box. The support base creates stability for the valve and avoids twisting of the pipe, but it also absorbs high loads and centres the down pipe installed on top of the valve ensuring valve operation at all times. The adaptor and surface box complete the valve access system. Besides giving access to the lower buried valve the surface box can bear media identification for easy recognition and, if required, customer specific logos.

The AVK MAGNUS range is also available with purge and bypass points to enable them to be used for the safe isolation of pipe sections between strategic valves. The purge and bypass points are fully welded and pressure rated the same as the main valve. The purge valve is sealed off with a pressure retaining plug and can be operated with a stainless steel lever.



Valve access system



Stem extension
and purge points



Lever

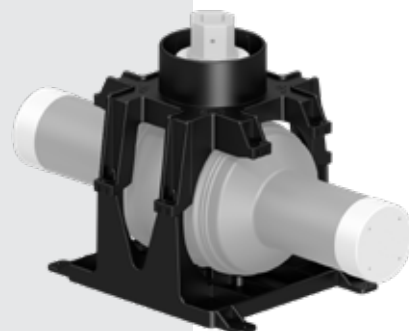

Support base

FEATURES & BENEFITS

All spigot ends can be delivered with the **double spigot length** option allowing for a second electro fusion weld if the first one fails.

The spigots are butt welded to the body. **Visual beads** reassuring joint quality for each weld in complete pipe line.

The valves are equipped with two **weather seals** avoiding ingress of ground water and dirt into the operating mechanism.

The stem is of the **anti blow-out** type and has a double O-ring seal to guarantee safety at all times.

Body and spigots manufactured from high performance **PE100-RC**. This material is extremely resistant to slow crack propagation and can be welded to all PE100 and PE80 pipes.

All AVK MAGNUS valves are designed with a **full bore** ensuring a low pressure drop and greater flow through the valve for the same pressure. The large bore allows for pigging of pipes.

The **spigot ends are machined** on the inside as well as on the outside, guaranteeing a uniform wall thickness, allowing for optimal welding of electro fusion couplers and the smooth inner surface prevents deposits and will minimise flow resistance.

The floating ball principle and **special shaped ball seat** with large sealing surface are designed to ensure sealing at all times and be less affected by dirt or debris that might be in the pipeline.

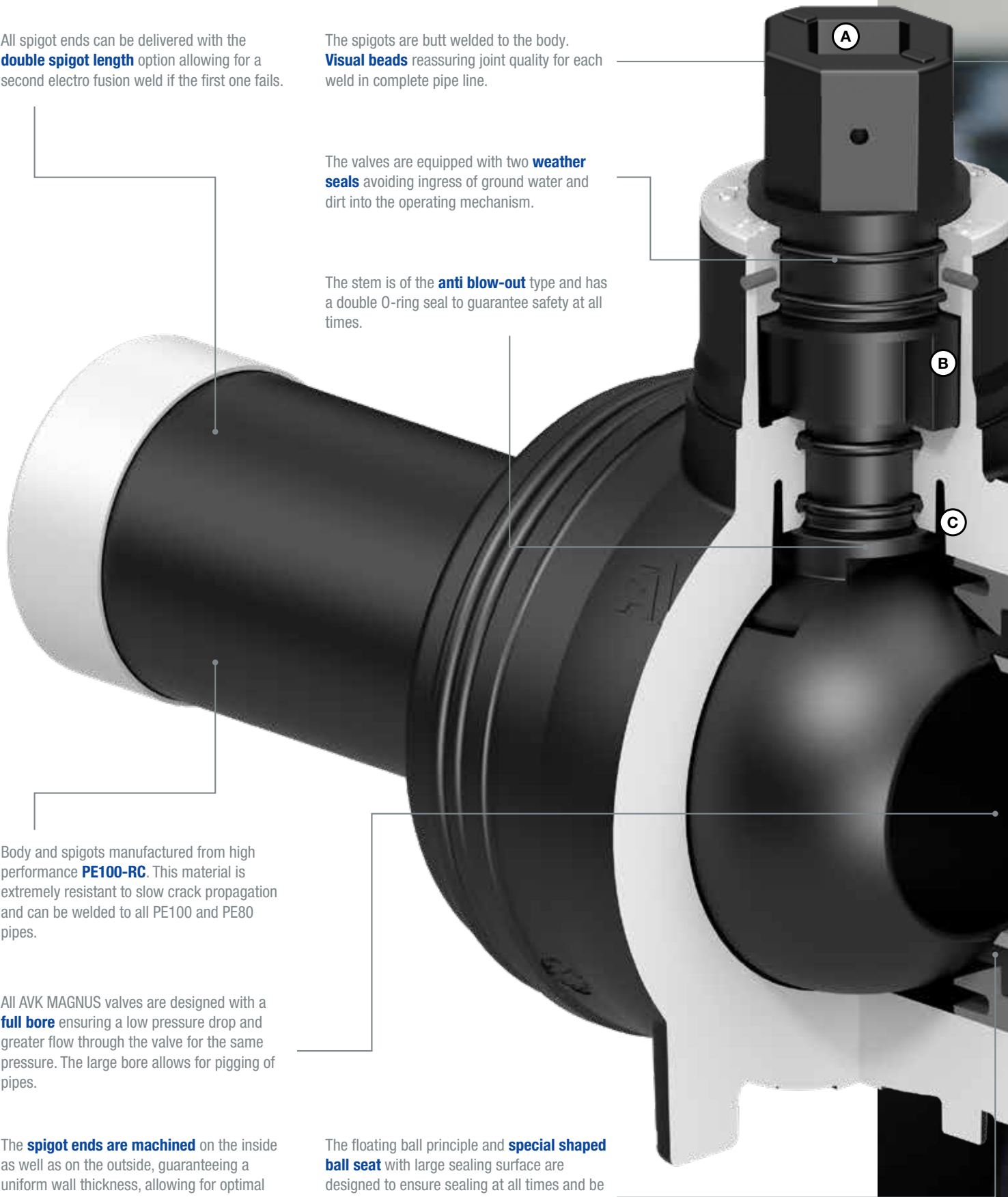

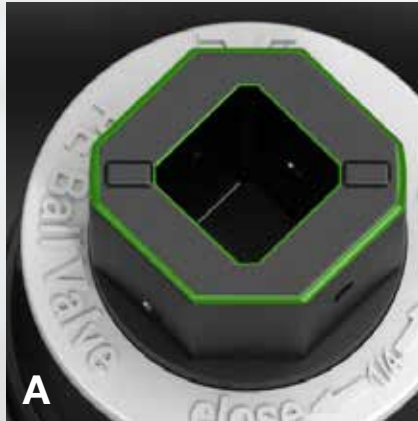

A Due to the **internal and external drive** the valves can be operated by all standardised spindles.

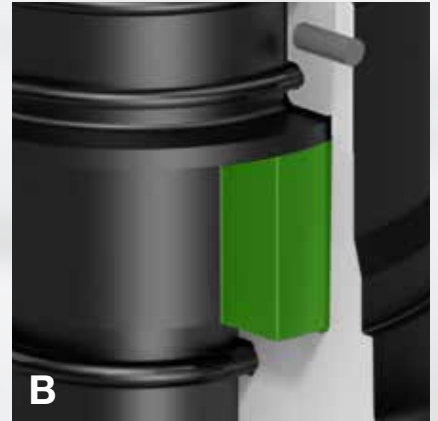

B If the valve is over torqued during opening or closing, the connector is designed to fail before the valve seals, thus preventing a leak to atmosphere. The **safety connector** can be replaced under live conditions.

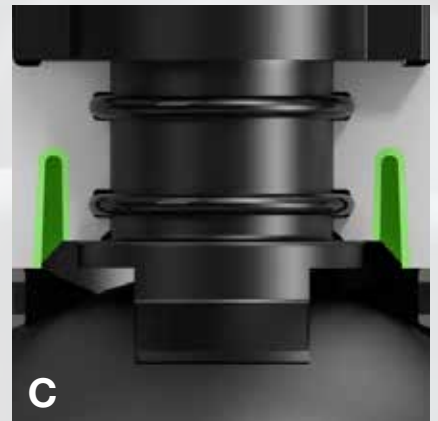

C The **flexible spindle shaft** ensures equal compression around the O-rings when loaded by internal pressure. At the same time the groove will adapt to any deformation as a result of upstream pressure on the ball when the valve is in the closed position.

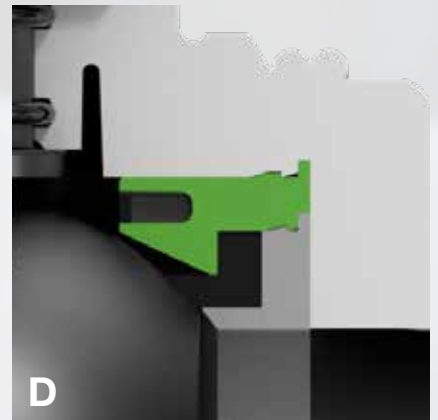

D The **seat retainer and support ring** design ensure the ball seat is kept in place at all times. This optimal design prevents the ball seat from being dislodged, which guarantees a good functionality throughout the years.

QUALITY IN EVERY STEP

Construction & material selection

The AVK MAGNUS ball valves are made out of PE100-RC offering excellent resistance to slow crack propagation and can be welded to all PE100 and PE80 pipes.

The main internal construction of the AVK MAGNUS is based on a large ball seat arrangement for reliable sealing performance. By means of a seat retainer and dedicated support ring, the ball seat is firmly kept in place. The seat compression is accurately set by fixating the ball seat arrangement into the body, prior to welding. The spigots are butt welded to the body. Butt welding is chosen because of the long term practically proven reliability. For the welding, the leading DVS2207-1 guidelines are strictly followed. The skimming and welding steps are performed by fully automated welding stations, guaranteeing ultimate consistency of the ball valves.

For the sealing high quality and durable NBR rubber is used. The ball is made out of an engineering plastic that has very good scratch resistance and is carefully machined for lowest operating torque. Next to this, the chemical resistance to a very wide range of media is covered. The grease has been selected after numerous tests to achieve the maximum ease of operating. This universal grease has a very low wearing off from the lubricated surfaces, ensuring the long term performance of the valve.

Approvals & testing

AVK MAGNUS valves are fully type tested at an external worldwide reputable laboratory. The valves meet all the requirements of the EN1555-4, ISO4437-4, GB15558.3 and EN12201-4.

During type testing, the valves are not only submitted to various long and short term leaktightness checks, but also to rigorous pulling, bending and thermal cycling tests. The operating mechanism and connector can withstand high prescribed torques at extreme temperatures.

AVK Syntec is equipped with advanced test equipment, ensuring the highest quality of valves. Each valve is tested for operating torque and leaktightness at low and high pressure. Besides, per batch, valves undergo hydrostatic strength testing (at elevated temperatures) to confirm long term performance.

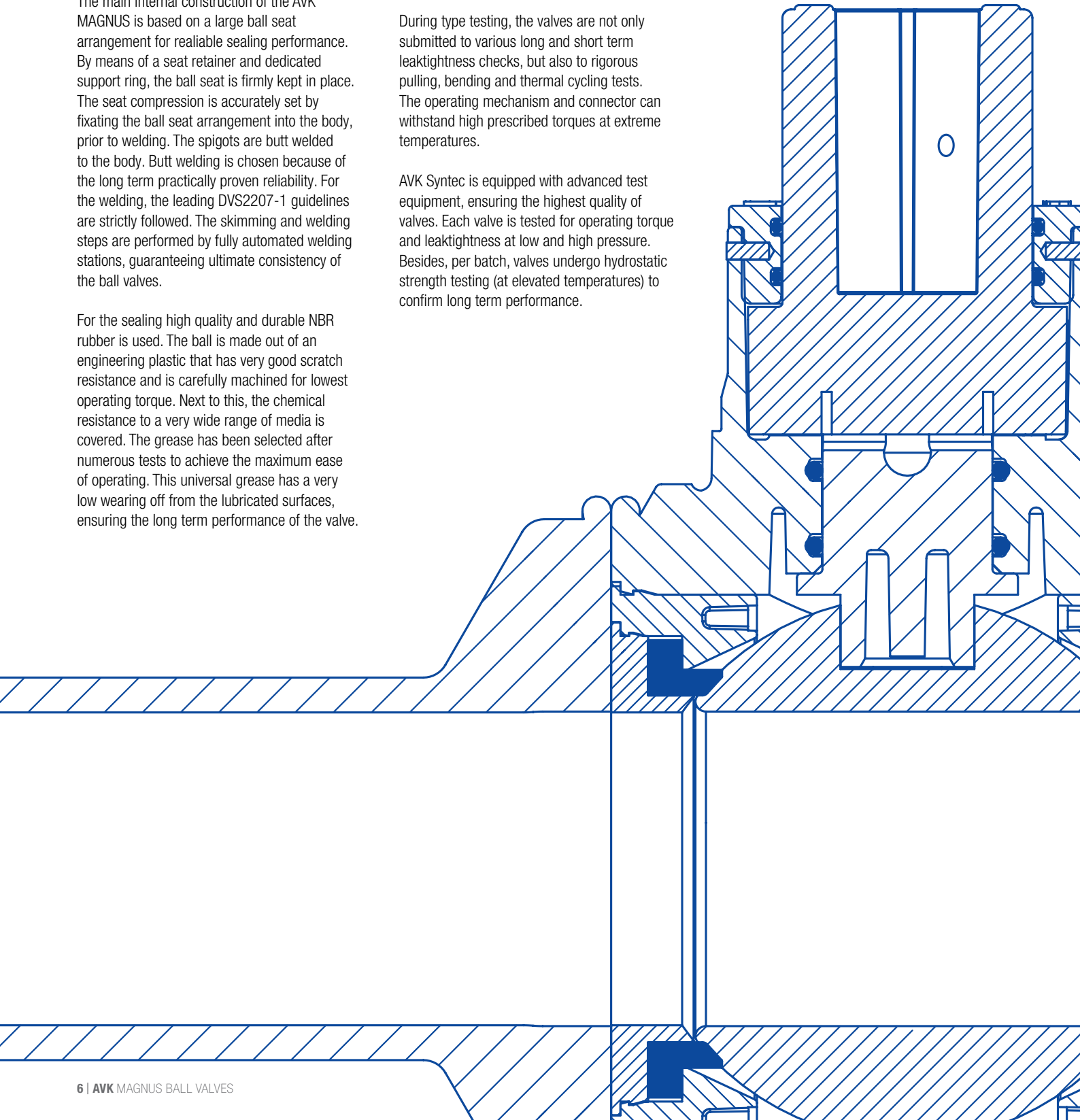

IDENTIFICATION & TRACEABILITY

Full traceability in a few simple steps...

All AVK MAGNUS valves carry a unique serial number that is permanently dotmarked in the valve body directly after the welding process. Via this serial number all testing and production data for each individual valve can be retrieved. Also batch information of the raw material for every component is stored.

In response to increasing demand on accurate and effective asset management, AVK has developed the AVIT system: AVK Valve Installation Tracker. With the AVIT system, key valve and installation data is stored together.

This allows customers to fully record, track and identify exactly where their AVK valves are located. The AVK MAGNUS valve carries a QR code that can be scanned by using a simple app and smartphone. Next to the exact location data, a picture of the installed valve is saved.

AVIT Web portal

Via the AVIT Web portal the recorded valve data, including all the customer valve installation information gathered by the mobile application, can be accessed at a glance. This allows for easy and effective auditing of installed works.



AVK BELGIUM NV

Zoomstraat 6A
9160 Lokeren
Belgium
www.avkvalves.be

Tel.: +32 9 348 13 13
Fax.: +32 9 349 39 64
info@avkvalves.be

Copyright©AVK Belgium 2016

Expect... 